

ARTUR

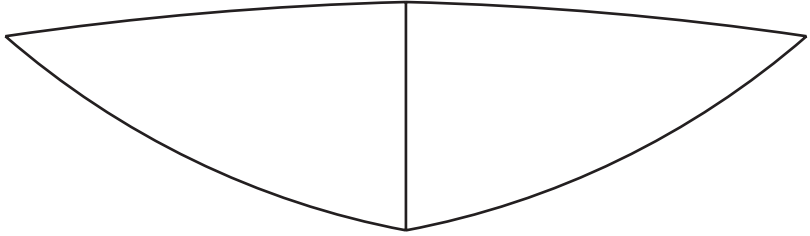

**WOLFGANG GRAU**

# Montageanleitung • Assembly instructions • Notice de montage • Istruzioni montaggio

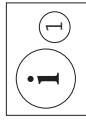

Achtung! Nicht Maßstabgerecht! • Attention! Not drawn to scale! • Attention! Non à l'échelle • Attenzione! Non in scala!

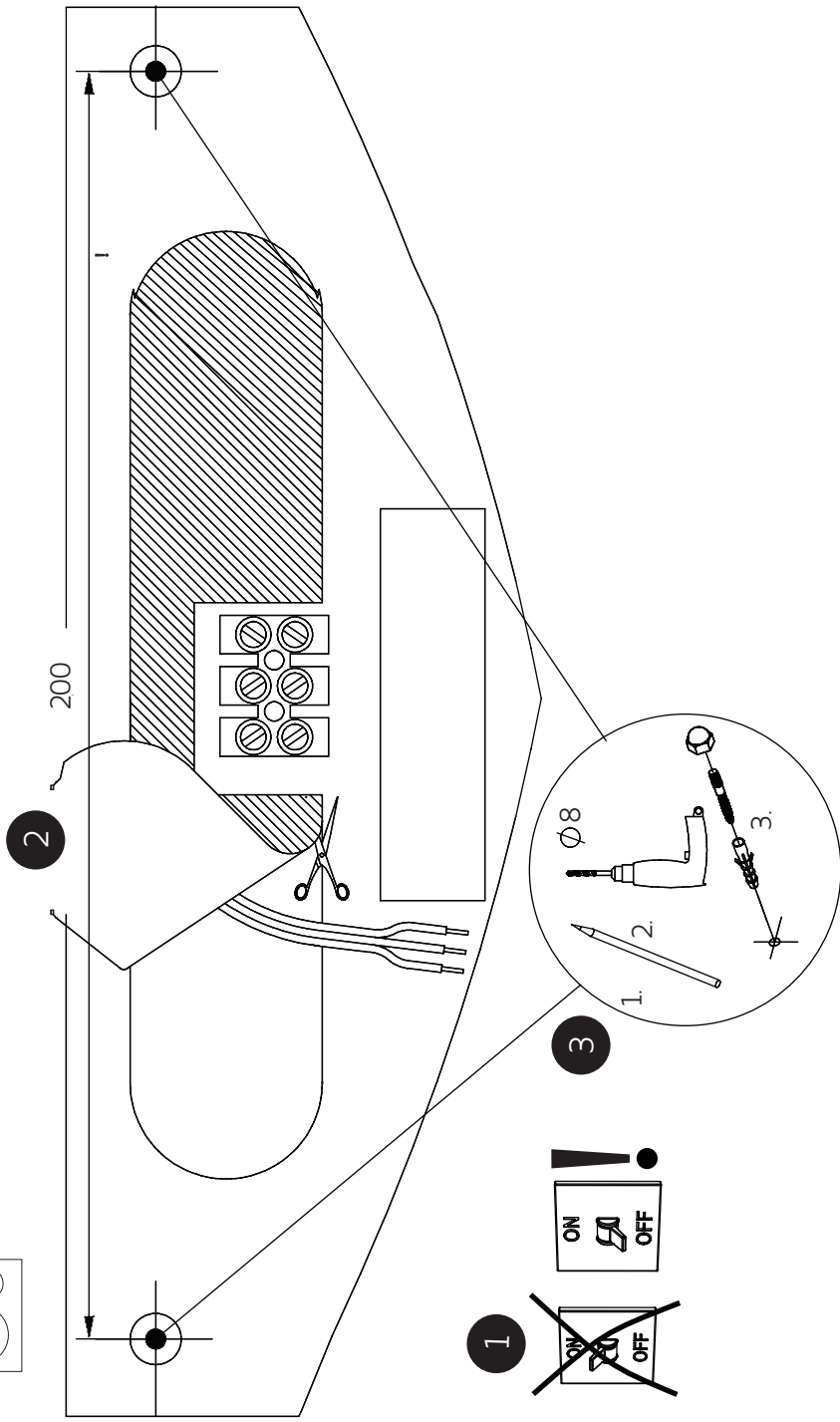



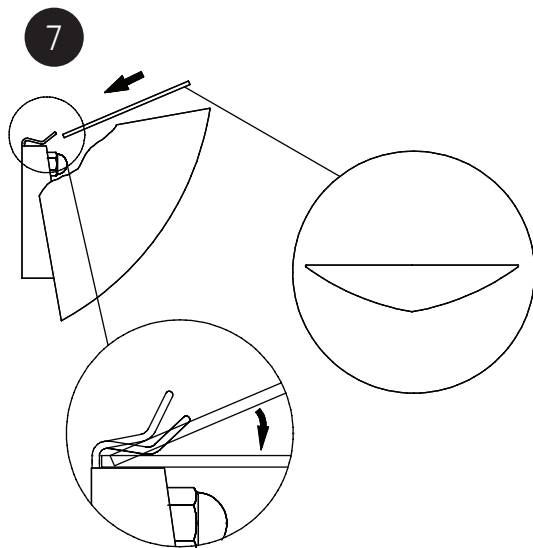
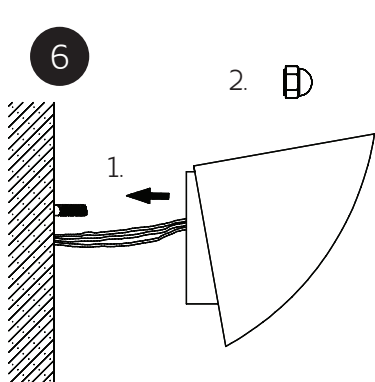
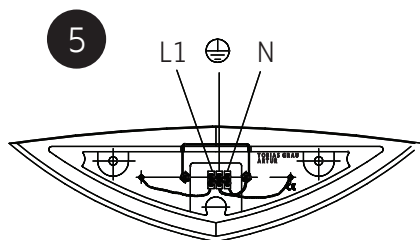
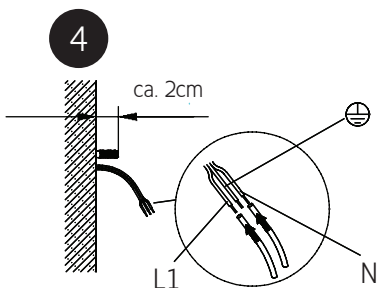
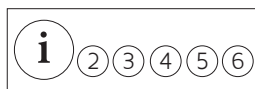









Anschluss der Leuchte • Connection of the light •  
Branchement du luminaire • Installazione della lampadina



# i DEUTSCH

- ① Die Auswahl der richtigen Befestigungsmittel obliegt dem Installateur.
- ② Schutzschläuche über die ganze Länge der Kabel ziehen.
- ③ Dimmer für Halogen-Hochvoltlampen verwenden.
- ④ Lassen Sie das Leuchtmittel vor dem Wechsel abkühlen.
- ⑤ Den Glaskolben nicht mit den Fingern anfassen.
- ⑥ Bitte die Leuchte ausschließlich mit einem trockenen Tuch reinigen. Wir empfehlen Microfasertücher für empfindliche Oberflächen. Das Reinigen muss in abgekühltem Zustand erfolgen.
- ⑦ Die Leuchte ist im Gußverfahren hergestellt. Farbschattierungen und kleine Unebenheiten sind der Herstellungsweise entsprechend und geben jeder einzelnen Leuchte ihren individuellen Charakter

ARTUR	
	Montage auf normal entflammaren Flächen zulässig.
	Bei Montage nach unten leuchtend, max. 100W / ES 80W zulässig!
	Mindestabstand zu angestrahlenen Flächen 0,3m!
	Beschädigtes Sicherheitsglas austauschen.
	EN 60598
	73/23/EWG   89/336/EWG
100W / ES 80W	   R7s max. 100W / ES 80W L=74,9mm
150W / ES 120W	   R7s max. 150W / ES 120W L=74,9mm



Diese Leuchte ist geeignet für Leuchtmittel der Energieklasse:  
 Diese Leuchte wird verkauft mit einem Leuchtmittel der Energieklasse:

E - A++  
 C

## Garantie:

Sie haben ein hochwertiges Produkt erworben, welches mit Sorgfalt produziert und verpackt worden ist. Sollten Sie dennoch einmal Grund zur Beanstandung haben, wenden Sie sich bitte ausschließlich an Ihr Einrichtungs- bzw. Leuchtenhaus. Geben Sie bitte die auf der letzten Seite genannte Endkontrollnummer an. Ihre Reklamation wird bei uns im Hause umgehend bearbeitet. Bitte haben Sie Verständnis, dass eine Garantie unsererseits nur bei sachgemäßer Montage übernommen werden kann - wir empfehlen daher Fachbetriebe. Fragen Sie auch Ihr Einrichtungs- bzw. Leuchtenhaus diesbezüglich.

# i ENGLISH

- ① It is the installer's responsibility to choose the correct fixing method.
- ② Cover the hole length of the ceiling electrical cable with the attached protection tube.
- ③ Use dimmers for high-voltage halogen lamps.
- ④ Please let the lighting element cool down before changing.
- ⑤ Don't touch glass with fingers.
- ⑥ We recommend to clean the track with a moist cotton cloth only. Cleaning must only be carried out when the lamp is cool.
- ⑦ The lamp has been produced using the casting process. Different shades of color and small unevennesses are natural according to the method of production and give each single lamp its individual character.

ARTUR	
	Mounting on normally flammable surfaces permissible.
	Fixing the lamp lighting downwards, max.100W / ES 80W is allowed!
	Minimum distance from lighted objects 0,3m!
	Replace damaged safety glass
	EN 60598
	73/23/EWG   89/336/EWG
100W / ES 80W	R7s max. 100W / ES 80W L=74,9mm
150W / ES 120W	R7s max. 150W / ES 120W L=74,9mm

This luminaire is compatible with bulbs of the energy classes:  
This luminaire is sold with a bulb of the energy class:













E - A++  
C

## Warranty:

You have acquired a high-quality product, which has been manufactured and packed with care. Should you nevertheless have grounds for complaint, please contact your local specialist furniture or lighting retailer, quoting the final inspection number as noted on the last page hereof. We will deal with your complaint immediately. This warranty applies only to products that have been fitted appropriately – we therefore recommend fitting by qualified personnel. Your local furniture or lighting specialist will be able to advise you accordingly.

# i FRANÇAIS

- ① Le choix des moyens de fixations appropriés incombe à l'installateur.
- ② Veuillez recouvrir par le tuyau de protection toute la longueur du câble électrique sortant du plafond.
- ③ Utiliser un variateur pour ampoule halogène haute tension.
- ④ Laisser refroidir l'ampoule avant de la changer.
- ⑤ Ne pas toucher le verre avec les doigts.
- ⑥ Veuillez nettoyer le luminaire uniquement avec un chiffon sec. Nous recommandons des chiffons en microfibre. Le nettoyage doit s'effectuer uniquement lorsque la lampe est froide.
- ⑦ Cette luminaire a été coulée en fonte; il est donc naturel qu'elle présente des variations de nuance et des irrégularités de surface, qui confèrent à chaque exemplaire son caractère unique et original.

ARTUR	
	Convient pour le montage sur surfaces normalement inflammables.
	Pour un montage vers le bas, max. autorisé 100 W / ES 80W
	0,3 m Distance minimale de la surface éclairée 0,3m!
	→  Remplacer le verre de sécurité endommagé
	EN 60598
	73/23/EWG   89/336/EWG
100W / ES 80W	   R7s max. 100W / ES 80W L=74,9mm
150W / ES 120W	   R7s max. 150W / ES 120W L=74,9mm











 Ce luminaire est prévu pour des sources lumineuses de classe énergétique: E - A++  
Ce luminaire peut uniquement être équipé de tubes fluorescents compacts, classe énergétique: C

## Garantie:

Vous venez de faire l'acquisition d'un produit de haute qualité, fabriqué et emballé avec le plus grand soin. Si vous aviez cependant un motif de réclamation, veuillez vous adresser immédiatement à votre magasin d'ameublement ou de luminaires, en indiquant le numéro de contrôle final mentionné à la dernière page. Notre société donnera suite sans tarder à votre réclamation. Vous comprenez aisément que nous ne pouvons assurer de garantie que dans le cas où le montage du matériel a été effectué correctement - par conséquent, nous vous recommandons de vous adresser à un spécialiste. Demandez conseil à votre magasin d'ameublement ou de luminaires.

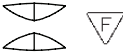
# i ITALIANO

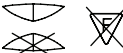
- ① La scelta del giusto materiale per l' attacco spetta all' installatore.
- ② Inserire i tubi protettivi per tutta la lunghezza del cavo connettore.
- ③ Utilizzare regolatori per lampade alogene.
- ④ Fate raffreddare la lampadina prima di cambiarla.
- ⑤ Non toccare il vetro con le dita.
- ⑥ Per favore pulire la lampada esclusivamente con un panno asciutto. Si consiglia di utilizzare tessuti in microfibra. Le lampade devono essere fredde durante la pulizia.
- ⑦ Le lampade vengono costruite impiegando la tecnica di fusione. Piccole irregolarità sono conformi ad un tradizionale modo di produzione e conferiscono alla lampada il suo stile e carattere individuale.

ARTUR	
	Montaggio su normali superfici infiammabili ammesso.
	Montaggio con fonte luminosa verso il basso possibile con al massimo 100W / ES 80W
	0,3 m Distanza minima dagli oggetti da illuminare 0,3m!
	Sostituire il vetro di sicurezza danneggiato.
	EN 60598
	73/23/EWG   89/336/EWG
100W / ES 80W	   R7s max. 100W / ES 80W L=74,9mm
150W / ES 120W	   R7s max. 150W / ES 120W L=74,9mm

 Questa lampada è idonea a sorgenti luminose con classe energetica: **E - A++**  
 Questa lampada deve essere equipaggiata con una lampadina a risparmio di classe energetica: **C**

## Garanzia:

Avete deciso di acquistare un prodotto d' alto valore, prodotto ed imballato con accuratezza. Qualora ci fossero motivazioni oggettive per un reclamo, indirizzarle immediatamente al vostro rivenditore o negozi specializzati. Indicare il numero di controllo finale riportato nell' ultima pagina. Il vostro reclamo verrà elaborato presso di noi. Considerate che da parte nostra possiamo assumere la garanzia del prodotto soltanto nel caso in cui il montaggio avvenga a regola d' arte: consigliamo dunque di rivolgersi ad aziende d' installazione specializzate; chiedere anche a tal riguardo al vostro rivenditore o a negozi specializzati.

Endkontrollnummer	2 Jahre Garantie
Final inspection number	2 years guarantee
Numéro de contrôle final	2 ans de garantie
Numero di controllo finale	2 anni di garanzia