

SATURN

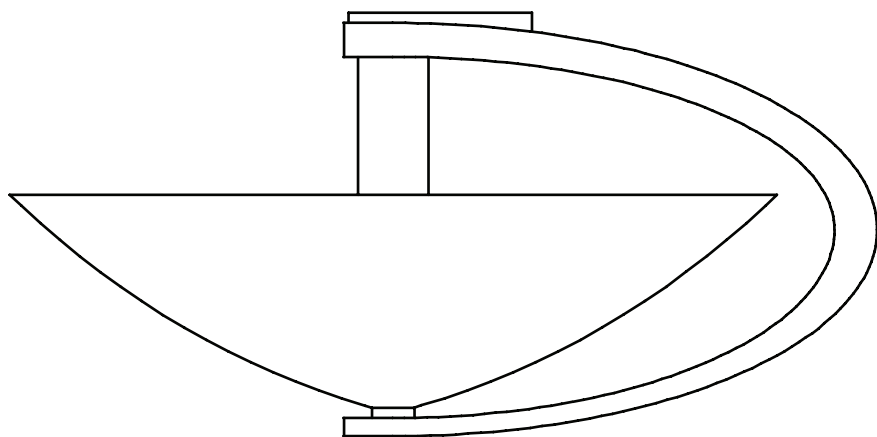

Montageanleitung • Assembly instructions • Notice de montage • Istruzioni montaggio

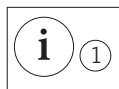

1

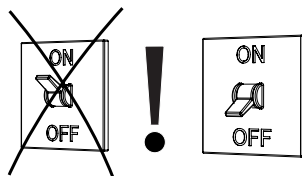

2

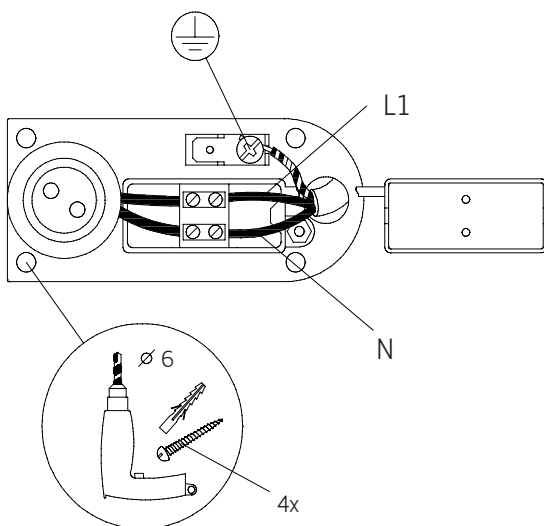

3

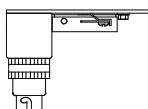
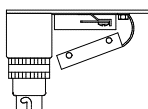
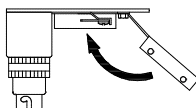

Montageanleitung • Assembly instructions • Notice de montage •
Istruzioni montaggio

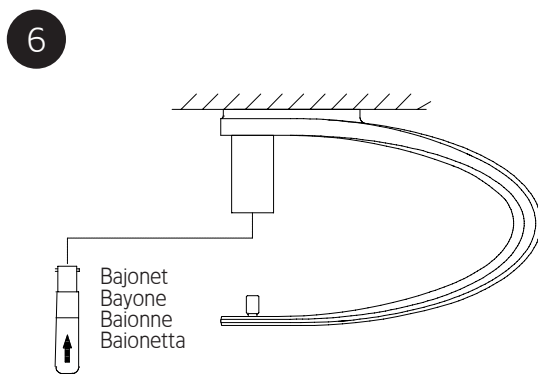
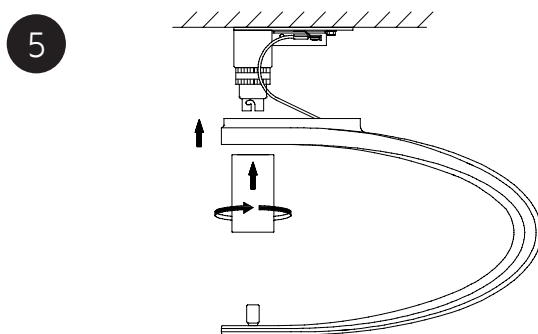
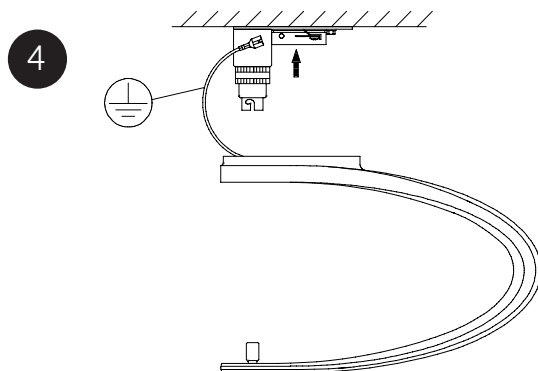
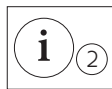

Montageanleitung • Assembly instructions • Notice de montage •
Istruzioni montaggio

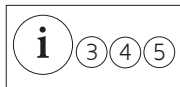

7

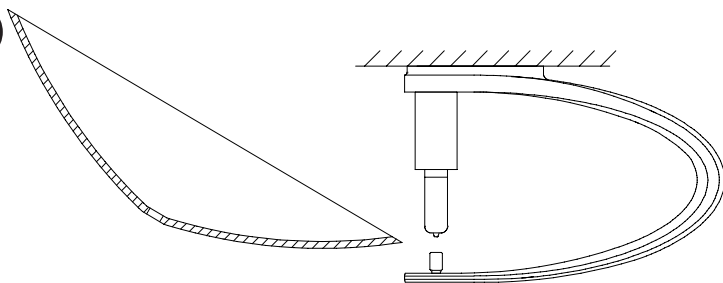

8

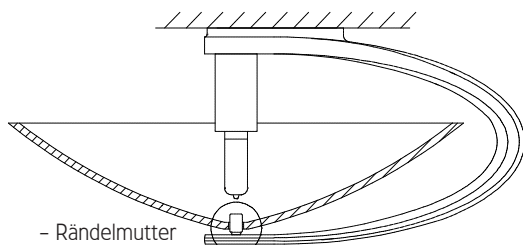

- Rändelmutter
- Kurlled nut
- l'écrou cranté!
- Bullone



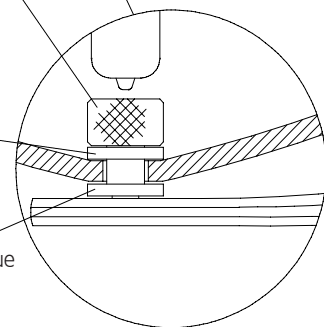

- Siliconscheibe
- Silicondisc
- Rondelle en silicone
- Rondella silicone

- Plasticscheibe
- Plasticdisc
- Rondelle en plastique
- Rondella plastica



i DEUTSCH

- 1 Die Auswahl der richtigen Befestigungsmittel obliegt dem Installateur.
- 2 Zum Leuchtmittelwechsel Glas vom Leuchtarm abnehmen!
- 3 Rändelmutter mit Gefühl anziehen! Bei zu kräftigem Anziehen kann das Glas brechen!
- 4 Bitte beachten Sie:
Zum Reinigen der polierten Ausführungen verwenden Sie gebräuchliche Metallputzmittel und weiche Tücher. Zur Reinigung der Chrome-Satin Oberfläche verwenden Sie bitte lauwarmes Wasser mit etwas Spülmittel und ein weiches Tuch (bitte keine sauren Spülmittel, wie Produkte auf Zitro- oder Apfelbasis, verwenden). Das Reinigen muss in abgekühltem Zustand erfolgen. Die Leuchte ist im Gussverfahren hergestellt. Farbschattierungen und kleine Unebenheiten sind der Herstellungsweise entsprechend und geben jeder einzelnen Leuchte ihren individuellen Charakter. Wir wünschen Ihnen viel Freude mit Ihrer Leuchte.
- 5 Das Glas Ihrer Leuchte ist mundgeblasen. Die Schönheit und Individualität Ihres Glases kann nur mit diesem besonderen Herstellungsverfahren erreicht werden. Unregelmäßigkeiten in der Oberfläche und kleine Luftblasen im Glas stellen keinen Qualitätsmangel dar. Sie verleihen vielmehr jeder Leuchte ihren persönlichen Charakter.

SATURN	
	Montage auf normal entflammaren Flächen zulässig.
	73/23/EWG 89/336/EWG
	Niederdrucklampen verwenden!
	SATURN 36: B15d / max.150W / L=86mm
	SATURN 50: B15d / max.250W / L=98mm



Diese Leuchte ist geeignet für Leuchtmittel der Energieklasse:
Diese Leuchte wird verkauft mit einem Leuchtmittel der Energieklasse:





E - A++
D

Garantie:

Sie haben ein hochwertiges Produkt erworben, welches mit Sorgfalt produziert und verpackt worden ist. Sollten Sie dennoch einmal Grund zur Beanstandung haben, wenden Sie sich bitte ausschließlich an Ihr Einrichtungs- bzw. Leuchtenhaus. Geben Sie bitte die auf der letzten Seite genannte Endkontrollnummer an. Ihre Reklamation wird bei uns im Hause umgehend bearbeitet. Bitte haben Sie Verständnis, dass eine Garantie unsererseits nur bei sachgemäßer Montage übernommen werden kann - wir empfehlen daher Fachbetriebe. Fragen Sie auch Ihr Einrichtungs- bzw. Leuchtenhaus diesbezüglich.

i ENGLISH

- ① It is the installer's responsibility to choose the correct fixing method.
- ② To change the bulb please remove the glass!
- ③ Tighten the knurled nut gently! Excessive force can break the glass!
- ④ Please notice:
To clean the polished versions use a customary metal cleaning agent and a soft rag. To clean the chrome-satin surface, please use lukewarm water with a little washing-up liquid (be sure not to use any acid rinsing agents such as products based on lemon or apple). Cleaning must only be carried out when the lamp is cool. The lamp has been produced using the casting process. Different shades of color and small unevennesses are natural according to the method of production and give each single lamp its individual character. We wish you long-lasting pleasure with your lamp.
- ⑤ The glass of your lamp is mouth-blown. The beauty and individuality of the glass can only be reached due to this special production process. An unregular surface and small air bubbles in the glass do not represent a lack of quality. They rather give each lamp its personal charm.

SATURN	
	Mounting on normally flammable surfaces permissible.
	73/23/EWG 89/336/EWG
	Use low pressure lamps!
	SATURN 36: B15d / max.150W / L=86mm
	SATURN 50: B15d / max.250W / L=98mm



This luminaire is compatible with bulbs of the energy classes:
This luminaire is sold with a bulb of the energy class:





E - A++
D

Warranty:

You have acquired a high-quality product, which has been manufactured and packed with care. Should you nevertheless have grounds for complaint, please contact your local specialist furniture or lighting retailer, quoting the final inspection number as noted on the last page hereof. We will deal with your complaint immediately. This warranty applies only to products that have been fitted appropriately – we therefore recommend fitting by qualified personnel. Your local furniture or lighting specialist will be able to advise you accordingly.

i FRANÇAIS

- ① Le choix des moyens de fixations appropriés incombe à l'installateur.
- ② Pour changer l'ampoule, enlever le verre!
- ③ Visser avec précaution l'écrou! Le verre peut se briser si l'écrou est trop serré!
- ④ Veuillez noter:
Pour les modèles en bronze poli, utiliser un nettoyant pour métal et un chiffon doux. Pour le nettoyage des surfaces en chrome-satin, veuillez utiliser de l'eau tiède avec un peu de produit vaisselle (ne pas utiliser de nettoyants acides, comme des produits à base de citron ou de pomme). Le nettoyage doit s'effectuer uniquement lorsque la lampe est froide. Ce luminaire a été coulé en fonte; il est donc naturel qu'il présente des variations de nuance et des irrégularités de surface, qui confèrent à chaque exemplaire son caractère unique et original. Nous vous souhaitons beaucoup de satisfaction avec votre nouvelle lampe.
- ⑤ Le verre de votre luminaire est soufflé à la bouche. La beauté et le caractère unique de votre verre ne peuvent être atteints que grâce à ce procédé particulier de fabrication. Des irrégularités sur la surface et de petites bulles d'air ne représentent pas un défaut de qualité. Ils confèrent plutôt à chaque luminaire son propre caractère.

SATURN	
	Montage autorisé sur surfaces normalement inflammables.
	73/23/EWG 89/336/EWG
	Utiliser des ampoules basse pression!
	SATURN 36: B15d / max.150W / L=86mm
	SATURN 50: B15d / max.250W / L=98mm







Ce luminaire est prévu pour des sources lumineuses de classe énergétique: E - A++
Ce luminaire peut uniquement être équipé de tubes fluorescents compacts, classe énergétique: D

Garantie:

Vous avez de faire l'acquisition d'un produit de haute qualité, fabriqué et emballé avec le plus grand soin. Si vous aviez cependant un motif de réclamation, veuillez vous adresser immédiatement à votre magasin d'ameublement ou de luminaires, en indiquant le numéro de contrôle final mentionné à la dernière page. Notre société donnera suite sans tarder à votre réclamation. Vous comprenez aisément que nous ne pouvons assurer de garantie que dans le cas où le montage du matériel a été effectué correctement - par conséquent, nous vous recommandons de vous adresser à un spécialiste. Demandez conseil à votre magasin d'ameublement ou de luminaires.

i ITALIANO

- 1 La scelta del giusto materiale per l' attacco spetta all' installatore.
- 2 Per cambiare la lampadina togliere il vetro!
- 3 Girare il bullone con delicatezza. Il vetro si potrebbe rompere se viene usata troppa forza!
- 4 Avvertenze di manutenzione:
Le versioni lucide devono essere pulite con sostanze adatte alla pulizia di metalli e con panni morbidi. Per ripulire le superfici in cromo satinato occorre usare acqua tiepida con poco detersivo e un panno morbido (per favore non utilizzare nessun detersivo acido, come prodotti a base di limone o mela).
Le lampade devono essere fredde durante la pulizia. Le lampade sono prodotte impiegando la tecnica di fusione. Piccole irregolarità sono conformi ad un tradizionale modo di produzione e conferiscono alla lampada il suo stile e carattere individuale. Vi auguriamo di trascorrere molte ore liete illuminati dalla luce della vostra lampada.
- 5 Il vetro della vostra lampada è stato soffiato a bocca. La bellezza e l'individualità del vetro possono essere realizzate solo tramite questo processo di produzione. Irregolarità nella superficie e piccole bolle d'aria non ne intaccano la qualità bensì donano a ciascuna lampada un suo proprio carattere.

SATURN	
	Montaggio autorizzato su superfici normalmente infiammabili.
	73/23/EWG 89/336/EWG
	Utilizzare lampade a bassa pressione!
	SATURN 36: B15d / max.150W / L=86mm
	SATURN 50: B15d / max.250W / L=98mm



Questa lampada è idonea a sorgenti luminose con classe energetica:

E - A++

Questa lampada deve essere equipaggiata con una lampadina a risparmio di classe energetica: D

Garanzia:

Avete deciso di acquistare un prodotto d' alto valore, prodotto ed imballato con accuratezza. Qualora ci fossero motivazioni oggettive per un reclamo, indirizzarle immediatamente al Vostro rivenditore o negozi specializzati. Indicare il numero di controllo finale riportato nell' ultima pagina. Il Vostro reclamo verrà elaborato presso di noi. Considerate che da parte nostra possiamo assumere la garanzia del prodotto soltanto nel caso in cui il montaggio avvenga a regola d' arte: consigliamo dunque di rivolgersi ad aziende d' installazione specializzate; chiedere anche a tal riguardo al Vostro rivenditore o a negozi specializzati.

Endkontrollnummer	2 Jahre Garantie
Final inspection number	2 years guarantee
Numéro de contrôle final	2 ans de garantie
Numero di controllo finale	2 anni di garanzia