

# NAME TRIO

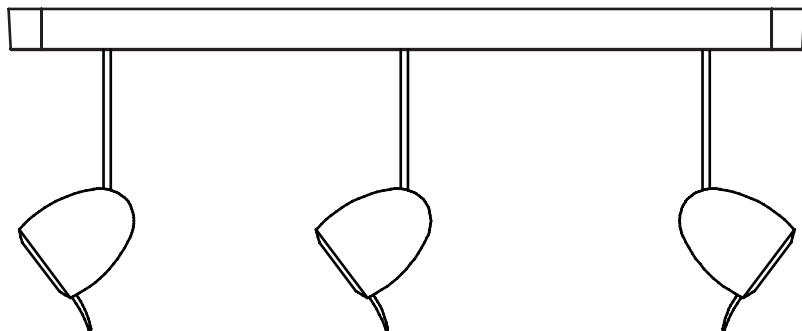

Montageanleitung • Assembly instructions • Notice de montage •  
Istruzioni montaggio

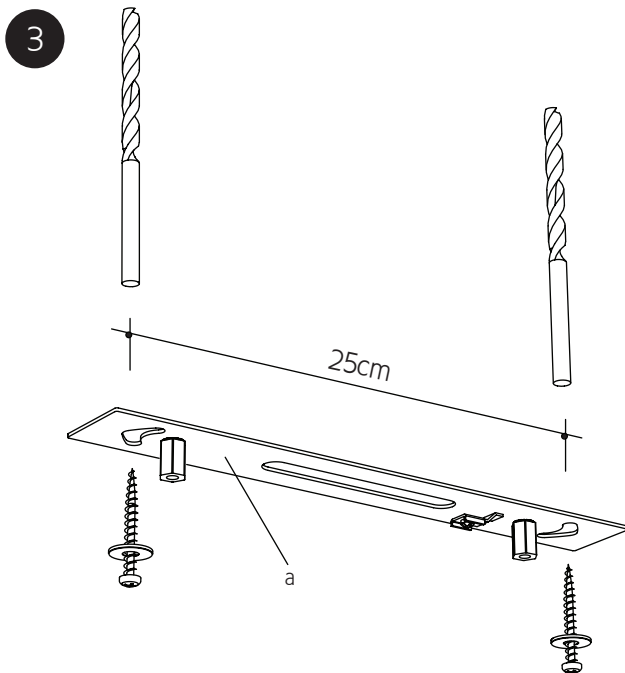
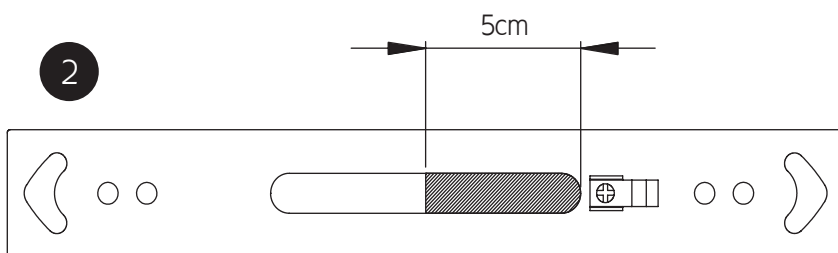
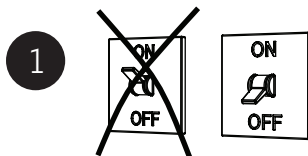
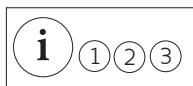

Montageanleitung • Assembly instructions • Notice de montage •  
Istruzioni montaggio

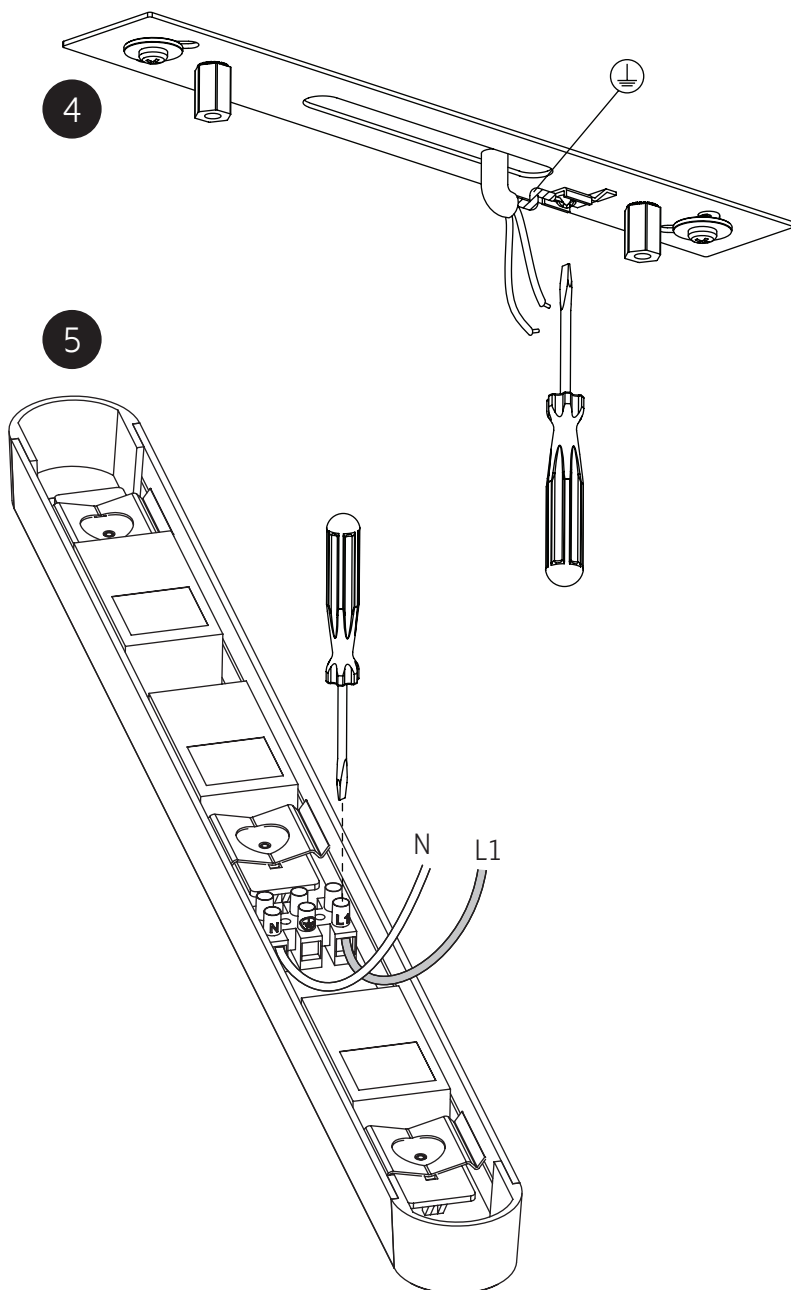

Montageanleitung • Assembly instructions • Notice de montage •  
Istruzioni montaggio



6

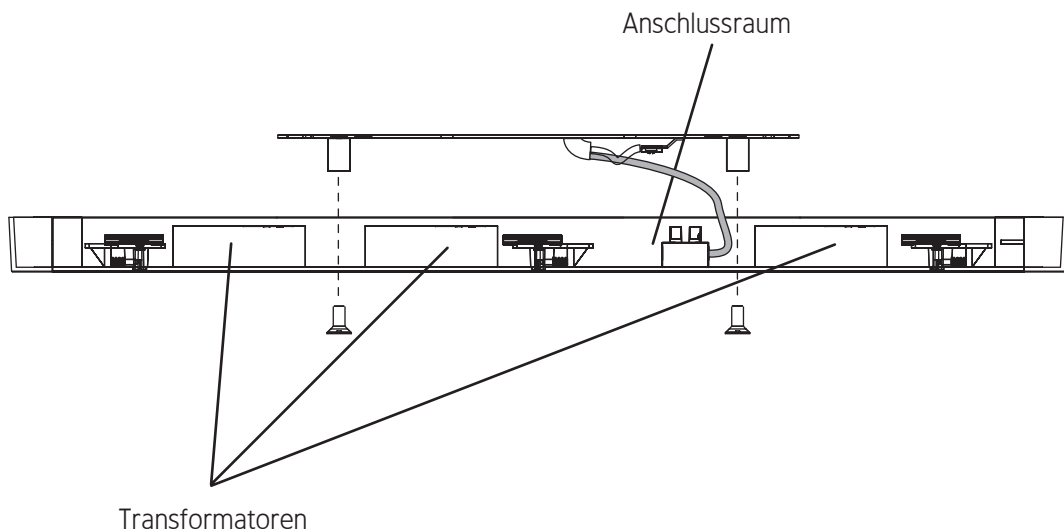
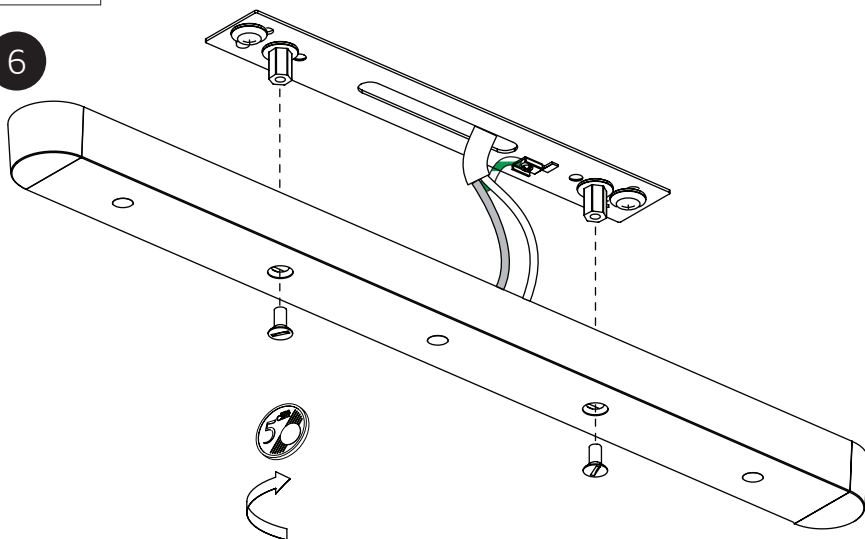

7

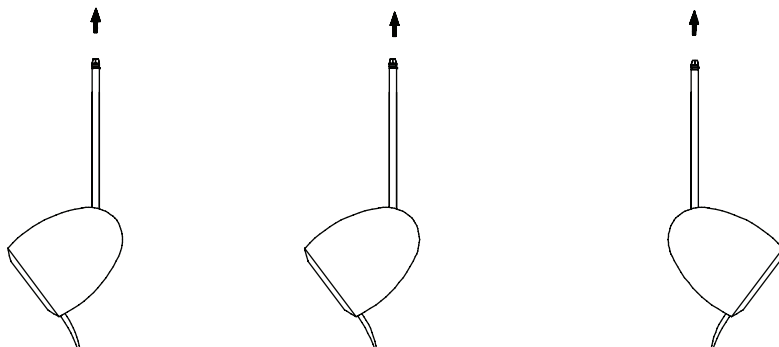



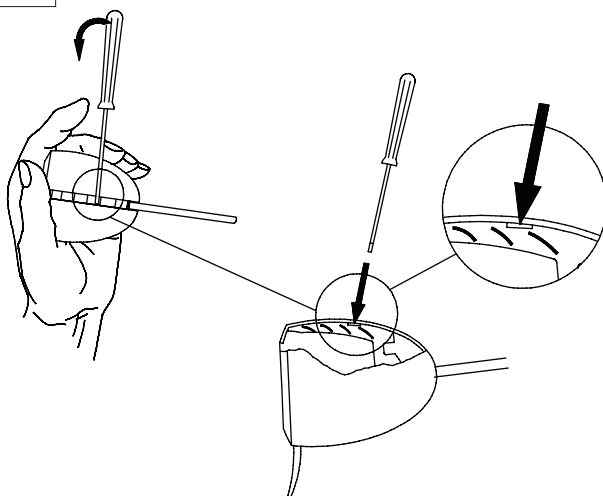

Wechseln des Leuchtmittels • Changing the bulb •  
Changement de l'ampoule • Sostituzione della lampadina



# **i** DEUTSCH

- ① Die Auswahl der richtigen Befestigungsmittel obliegt dem Installateur.
- ② Das Deckenauslasskabel muß im schraffierten Bereich durch die Befestigungsplatte geführt werden.
- ③ Vor Montage der Befestigungsplatte (a), gewünschte Ausrichtung der Leuchte beachten.
- ④ Nicht die Kabel einklemmen!
- ⑤ Schrauben abwechselnd anziehen.
- ⑥ Bitte beachten Sie, daß der Leuchtenkopf und der gebogene Hebel am Leuchtenkopf sehr heiß werden. Der Leuchtenkopf darf deshalb nur im abgekühlten Zustand eingestellt werden.
- ⑦ Bitte verwenden Sie ausschließlich qualitativ hochwertige Leuchtmittel. Wir empfehlen Leuchtmittel der Hersteller Philips und Osram.
- ⑧ Dimmer für Halogen-Niedervoltleuchten mit elektronischem Transformator verwenden.
- ⑨ Bitte die Leuchte ausschließlich mit einem trockenen Tuch reinigen. Wir empfehlen Microfasertücher für empfindliche Oberflächen. Das Reinigen muss in abgekühltem Zustand erfolgen.  
Wir wünschen Ihnen viel Freude mit Ihrer Leuchte.

NAME TRIO	
	Montage auf normal entflammaren Flächen zulässig.
	73/23/EWG   89/336/EWG
	Mindestabstand zu angestrahlten Flächen 0,5m!
	Niederdrucklampen verwenden!
	Pri.: 230C / 50-60Hz Sec.: 12V 3xGU5,3/ max.35W <b>ECO</b> - max.50W cool beam



Diese Leuchte ist geeignet für Leuchtmittel der Energieklasse:  
Diese Leuchte wird verkauft mit einem Leuchtmittel der Energieklasse:





E - A++  
B

## Garantie:

Sie haben ein hochwertiges Produkt erworben, welches mit Sorgfalt produziert und verpackt worden ist. Sollten Sie dennoch einmal Grund zur Beanstandung haben, wenden Sie sich bitte ausschließlich an Ihr Einrichtungs- bzw. Leuchtenhaus. Geben Sie bitte die auf der letzten Seite genannte Endkontrollnummer an. Ihre Reklamation wird bei uns im Hause umgehend bearbeitet. Bitte haben Sie Verständnis, dass eine Garantie unsererseits nur bei sachgemäßer Montage übernommen werden kann - wir empfehlen daher Fachbetriebe. Fragen Sie auch Ihr Einrichtungs- bzw. Leuchtenhaus diesbezüglich.

# **i** ENGLISH

- ① It is installer`s responsibility to choose the correct fixing method.
- ② The cable must be thread through the shaded area on the ceiling plate.
- ③ Before mounting plate (a) decide on the desired position.
- ④ Don` t jam the cables!
- ⑤ Tighten the screws alternately.
- ⑥ Please pay attention, that the lamp head and the curved level get very warm. Therefore, the lamp head can only be moved when the spot is cool.
- ⑦ Please use only quality means of illumination. We advice bulbs from the companies Philips and Osram.
- ⑧ Use dimmers for low-voltage halogen lamps with electronic transformers.
- ⑨ Please clean the lamp with a dry cloth only. We recommend microfiber cloths. Cleaning must only be carried out when the lamp is cool. We wish you long-lasting pleasure with your lamp.

NAME TRIO	
	Suitability for direct mounting on normal flammable surfaces.
	73/23/EWG I 89/336/EWG
	Minimum distance from lighted objects 0,5m!
	Use low pressure lamps!
	Pri.: 230C / 50-60Hz Sec.: 12V 3xGU5,3/ max.35W <b>ECO</b> – max.50W cool beam



This luminaire is compatible with bulbs of the energy classes:  
This luminaire is sold with a bulb of the energy class:





E - A++  
B

## Warranty:

You have acquired a high-quality product, which has been manufactured and packed with care. Should you nevertheless have grounds for complaint, please contact your local specialist furniture or lighting retailer, quoting the final inspection number as noted on the last page hereof. We will deal with your complaint immediately. This warranty applies only to products that have been fitted appropriately – we therefore recommend fitting by qualified personnel. Your local furniture or lighting specialist will be able to advise you accordingly.

# i FRANÇAIS

- 1 Le choix des moyens de fixations appropriés incombe à l'installateur.
- 2 Le câble du plafond doit être placé dans la partie hachurée à travers la plaque de fixation.
- 3 Avant le montage de la plaque de fixation (a), tenir compte de l'orientation souhaitée.
- 4 Ne pas coincer les câbles!
- 5 Serrer les vis a tour de rôle.
- 6 Veuillez noter que la tête du luminaire ainsi que son levier courbe deviennent très chauds. De ce fait, la tête du luminaire ne peut être orientée que lorsque celle-ci est froide.
- 7 Veuillez utiliser uniquement des ampoules de qualité. Nous conseillons les ampoules des fabricants Philips et Osram.
- 8 Utiliser un variateur pour luminaires halogènes basse-tension avec transformateur électronique.
- 9 Veuillez nettoyer le luminaire uniquement avec un chiffon sec. Nous recommandons des chiffons en microfibre. Le nettoyage doit s'effectuer uniquement lorsque celui-ci est froid. Nous vous souhaitons beaucoup de satisfaction avec votre nouveau luminaire.

NAME TRIO	
	Ne pas convient pour le montage sur surfaces normalement inflammables.
	73/23/EWG I 89/336/EWG
	0,5m Distance minimale de la surface éclairée 0,5m!
	Utiliser des ampoules basse pression!
	Pri.: 230C / 50-60Hz Sec.: 12V 3xGU5,3/ max.35W <b>ECO</b> - max.50W cool beam



Ce luminaire est prévu pour des sources lumineuses de classe énergétique: E - A++  
Ce luminaire peut uniquement être équipé de tubes fluorescents compacts, classe énergétique: B





## Garantie:

Vous avez de faire l'acquisition d'un produit de haute qualité, fabriqué et emballé avec le plus grand soin. Si vous aviez cependant un motif de réclamation, veuillez vous adresser immédiatement à votre magasin d'ameublement ou de luminaires, en indiquant le numéro de contrôle final mentionné à la dernière page. Notre société donnera suite sans tarder à votre réclamation. Vous comprenez aisément que nous ne pouvons assurer de garantie que dans le cas où le montage du matériel a été effectué correctement - par conséquent, nous vous recommandons de vous adresser à un spécialiste. Demandez conseil à votre magasin d'ameublement ou de luminaires.



# **i** ITALIANO

- 1 La scelta del giusto materiale per l'attacco spetta all'installatore.
- 2 Il cavo alimentatore del soffitto deve essere passato attraverso il piatto di installazione nell'area tratteggiata.
- 3 Fare attenzione alla posizione desiderata prima di montare il piattino (a).
- 4 Non schiacciare i cavi!
- 5 Alternare i giri di vite.
- 6 Attenzione: il corpo luminoso e la levetta diventano molto caldi. Per questo motivo il corpo luminoso può essere sistemato a piacimento solo quando la lampada si è raffreddata.
- 7 Per favore utilizzare lampadine di alta qualità. Consigliamo le marche Philips e Osram.
- 8 Utilizzare con i trasformatori elettronici solo regolatori di luminosità per lampade alogene a bassa tensione.
- 9 Per favore pulire il corpo illuminante esclusivamente con un panno asciutto. Si consiglia di utilizzare tessuti in microfibra. Le lampade devono essere fredde durante la pulizia. Vi auguriamo di trascorrere molte ore liete illuminati dalla luce della vostra lampadina.

NAME TRIO	
	Montaggio su normali superfici infiammabili non ammesso.
	73/23/EWG I 89/336/EWG
	0,5m Distanza minima dagli oggetti da illuminare 0,5m!
	Utilizzare lampade a bassa pressione!
	Pri.: 230C / 50-60Hz Sec.: 12V 3xGU5,3/ max.35W <b>ECO</b> - max.50W cool beam



Questa lampada è idonea a sorgenti luminose con classe energetica: **E - A++**  
Questa lampada deve essere equipaggiata con una lampadina a risparmio di classe energetica: **B**

## Garanzia:

Avete deciso di acquistare un prodotto d'alto valore, prodotto ed imballato con accuratezza. Qualora ci fossero motivazioni oggettive per un reclamo, indirizzarle immediatamente al vostro rivenditore o negozi specializzati. Indicare il numero di controllo finale riportato nell'ultima pagina. Il vostro reclamo verrà elaborato presso di noi. Considerate che da parte nostra possiamo assumere la garanzia del prodotto soltanto nel caso in cui il montaggio avvenga a regola d'arte: consigliamo dunque di rivolgersi ad aziende d'installazione specializzate; chiedere anche a tal riguardo al vostro rivenditore o a negozi specializzati.





Endkontrollnummer	2 Jahre Garantie
Final inspection number	2 years guarantee
Numéro de contrôle final	2 ans de garantie
Numero di controllo finale	2 anni di garanzia