

FB20-0

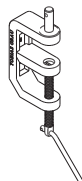

FB20-2



FB20-1



FB20-5

01 ① ② ③ ④ ⑤ ⑥

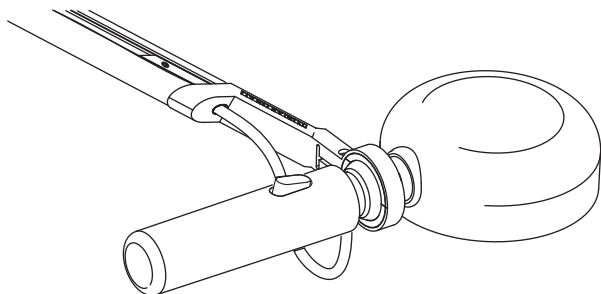

02

TABLE

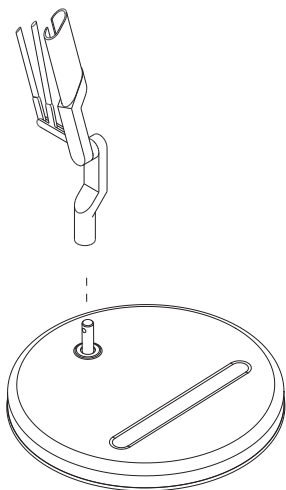

03 ⑦

CLAMP

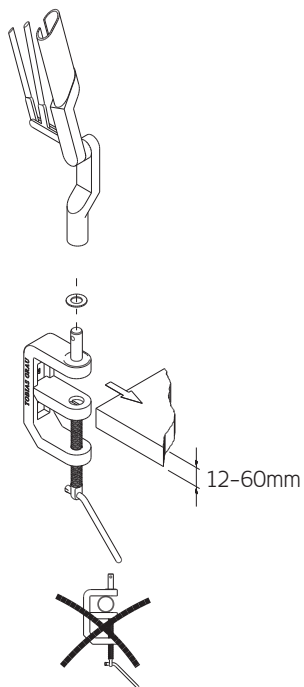

04 8

WALL

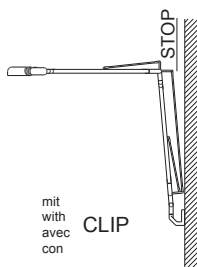
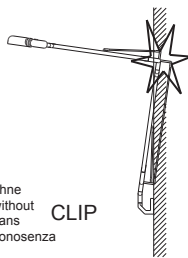
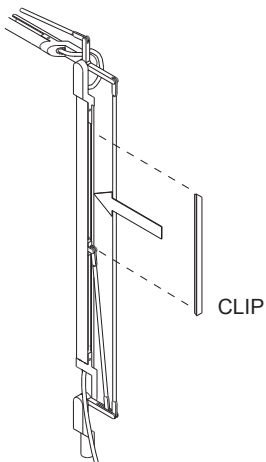
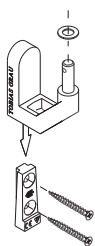
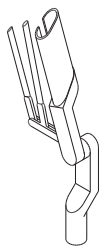

05

PIN

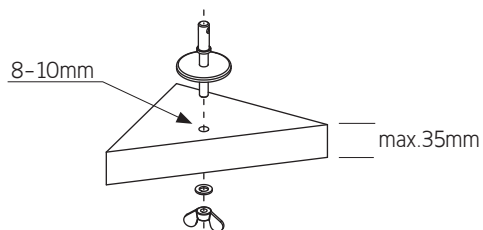

06 9

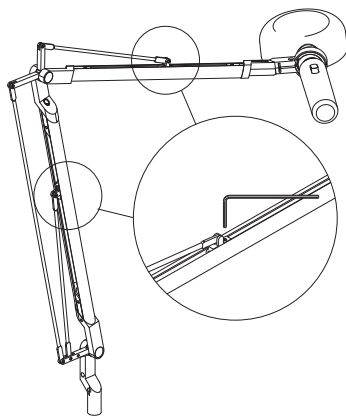







i 8 9



DEUTSCH

- ① Bitte die Leuchte ausschließlich mit einem trockenen Tuch reinigen. Wir empfehlen Microfasertücher für empfindliche Oberflächen. Das Reinigen muss in abgekühltem Zustand erfolgen.
- ② Chemische Reinigungsmittel (auch Spülmittel) zerstören den Kunststoff in kurzer Zeit.
- ③ Aufgrund der speziellen Ausführungen der Anschlußleitung, darf diese im Falle einer Beschädigung nur durch die Firma Tobias Grau ausgetauscht werden. Die Anschlußleitung entspricht in Ihren mechanischen und elektrischen Eigenschaften der Leitungsnorm HD21.
- ④ Den Glaskolben nicht mit den Fingern anfassen!
- ⑤ Lassen Sie das Leuchtmittel vor dem Wechsel abkühlen.
- ⑥ Verwenden Sie bitte ausschließlich Markenleuchtmittel wie z.B. von Osram und Philips.
- ⑦ Bei der Verwendung der Tischklemme sind Gebrauchspuren, insbesondere bei weichen Materialien, nicht auszuschließen. Hierfür kann die Fa. Tobias Grau keine Haftung übernehmen.
- ⑧ Die Auswahl der richtigen Befestigungsmittel obliegt dem Installateur.
- ⑨ Einstellung der Verstellkraft.

BILL HV	
	Diese Leuchte ist geeignet für Leuchtmittel der Energieklasse: E - A++ Diese Leuchte wird verkauft mit einem Leuchtmittel der Energieklasse: D
	Montage auf normal entflammaren Flächen zulässig.
	Mindestabstand zu angestrahlten Flächen 0,3m
	Niederdrucklampen verwenden!
	G9 - max. 60W / 48W ECO
	73/23/EWG 89/336/EWG

GARANTIE:

Sie haben ein hochwertiges Produkt erworben, welches mit Sorgfalt produziert und verpackt worden ist. Sollten Sie dennoch einmal Grund zur Beanstandung haben, wenden Sie sich bitte ausschließlich an Ihr Einrichtungs- bzw. Leuchtenhaus. Geben Sie bitte die auf der letzten Seite genannte Endkontrollnummer an. Ihre Reklamation wird bei uns im Hause umgehend bearbeitet. Bitte haben Sie Verständnis, dass eine Garantie unsererseits nur bei sachgemäßer Montage übernommen werden kann - wir empfehlen daher Fachbetriebe. Fragen Sie Ihr Einrichtungs- bzw. Leuchtenhaus diesbezüglich.



ENGLISH

- ① Please clean the lamp with a dry cloth. We recommend microfibre cloths for sensitive surfaces. Only clean the lamp when it has cooled down.
- ② Chemical cleaners (inclusive washing-up liquid) will destroy the synthetic material in a short time.
- ③ Owing to the specialised cable used in this product, damaged goods can only be replaced by Tobias Grau GmbH. The cables conform to Standard HD21.
- ④ Don't touch glass with fingers!
- ⑤ Please let the lighting element cool down before changing.
- ⑥ Please use exclusively brand name bulbs such as Osram and Phillips.
- ⑦ When using the table clamp, particularly with soft materials, signs of use cannot be excluded. Tobias Grau assumes no liability in such cases.
- ⑧ It is the installer's responsibility to choose the correct fixing method.
- ⑨ Setting the adjustable power.

BILL HV		
	This luminaire is compatible with bulbs of the energy classes: This luminaire is sold with a bulb of the energy class:	E - A++ D
	Mounting on normally flammable surfaces permissible.	
	Minimum distance from lighted objects 0,3m!	
	Use low pressure lamps!	
	G9 - max. 60W / 48W EC	
	73/23/EWG 89/336/EWG	







WARRANTY:

You have acquired a high-quality product, which has been manufactured and packed with care. Should you nevertheless have grounds for complaint, please contact your local specialist furniture or lighting retailer, quoting the final inspection number as noted on the last page hereof. We will deal with your complaint immediately. This warranty applies only to products that have been fitted appropriately – we therefore recommend fitting by qualified personnel. Your local furniture or lighting specialist will be able to advise you accordingly.



FRANÇAIS

- ① Veuillez nettoyer le luminaire uniquement avec un tissu sec. Nous conseillons des tissus micro pour surfaces sensibles. Le nettoyage doit s'effectuer lorsque le luminaire est froid.
- ② Les produits de nettoyage chimique (ainsi que produit vaisselle) détruisent la matière synthétique en peu de temps.
- ③ En raison de la fabrication spéciale de la connexion électrique, celle-ci ne peut être changée en cas de dégât uniquement que par la société Tobias Grau. La connexion électrique, de/part ses propriétés mécaniques et électriques, est conforme à la norme de connexion HD21.
- ④ Ne pas toucher le verre avec les doigts!
- ⑤ Laisser refroidir l'ampoule avant de la changer.
- ⑥ Veuillez utiliser uniquement des ampoules de marque comme par ex. Osram et Philips.
- ⑦ Lors de l'utilisation de la pince de bureau, des traces de fixation ne sont pas à exclure, notamment sur des surfaces tendres. Dans ce cas là, la société Tobias Grau ne peut pas en assumer la responsabilité.
- ⑧ Le choix des moyens de fixations appropriés incombe à l'installateur.
- ⑨ Régulation de la force d'ajustement.

BILL HV	
	Ce luminaire est prévu pour des sources lumineuses de classe énergétique: E - A++ Ce luminaire peut uniquement être équipé de tubes fluorescents compacts, classe énergétique: D
	Montage autorisé sur surface normalement inflammables.
	Distance minimale de la surface éclairée 0,3m!
	Utiliser des ampoules basse pression!
	G9 - max. 60W / 48W ECÒ
	73/23/EWG 89/336/EWG







GARANTIE:

Vous venez de faire l'acquisition d'un produit de haute qualité, fabriqué et emballé avec le plus grand soin. Si vous aviez cependant un motif de réclamation, veuillez vous adresser immédiatement à votre magasin d'ameublement ou de luminaires, en indiquant le numéro de contrôle final mentionné à la dernière page. Notre société donnera suite sans tarder à votre réclamation. Vous comprenez aisément que nous ne pouvons assurer de garantie que dans le cas où le montage du matériel a été effectué correctement - par conséquent, nous vous recommandons de vous adresser à un spécialiste. Demandez conseil à votre magasin d'ameublement ou de luminaires.



ITALIANO

- ① Per favore pulire la lampada esclusivamente con un panno asciutto. Si consiglia di utilizzare tessuti in microfibra. Le lampade devono essere fredde durante la pulizia.
- ② I detersivi chimici (anche per piatti) distruggono il materiale plastico in tempi brevissimi.
- ③ A causa della versione speciale del connettore, in caso di danneggiamento solo la Tobias Grau può effettuare il ricambio. Le caratteristiche meccaniche ed elettriche del connettore sono conformi alle norme di conduzione HD21.
- ④ Non toccare il vetro con le dita!
- ⑤ Fate raffreddare la lampadina prima di cambiarla.
- ⑥ Per favore utilizzare solo lampadine di marca come per es. Osram e Philips.
- ⑦ L'uso del morsetto da tavolo può lasciare inevitabilmente segni, specialmente su materiali morbidi. In questi casi la ditta Tobias Grau non prende nessuna responsabilità.
- ⑧ La scelta del giusto materiale per l'attacco spetta all'installatore.
- ⑨ Regolazione forza aggiustamento.

BILL HV	
	Questa lampada è idonea a sorgenti luminose con classe energetica: E - A++ Questa lampada deve essere equipaggiata con una lampadina a risparmio di classe energetica: D
	Montaggio autorizzato su superfici normalmente incombustibili.
	Distanza minima dagli oggetti da illuminare 0,3m!
	Utilizzare lampade a bassa pressione!
	G9 - max. 60W / 48W ECOC
	73/23/EWG 89/336/EWG

GARANZIA:

Avete deciso di acquistare un prodotto d'alto valore, prodotto ed imballato con accuratezza. Qualora ci fossero motivazioni oggettive per un reclamo, indirizzarle immediatamente al vostro rivenditore o a negozi specializzati. Indicare il numero di controllo finale riportato nell'ultima pagina. Il vostro reclamo sarà elaborato presso di noi. Considerate che da parte nostra possiamo assumere la garanzia del prodotto soltanto nel caso in cui il montaggio avvenga a regola d'arte: consigliamo dunque di rivolgersi ad aziende d'installazione specializzate; chiedere anche a tal riguardo al vostro rivenditore o a negozi specializzati.

Endkontrollnummer	2 Jahre Garantie
Final inspection number	2 years guarantee
Numéro de contrôle final	2 ans de garantie
Numero di controllo finale	2 anni di garanzia