

SHY BALL

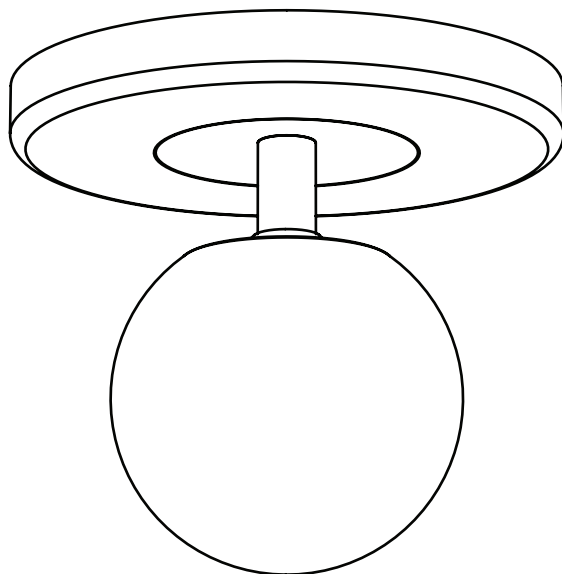

NOBIASGRAU

Montageanleitung • Assembly instructions • Notice de montage •
Istruzioni montaggio



1

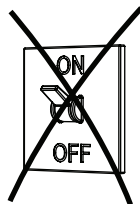
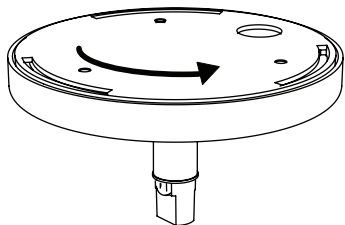

2

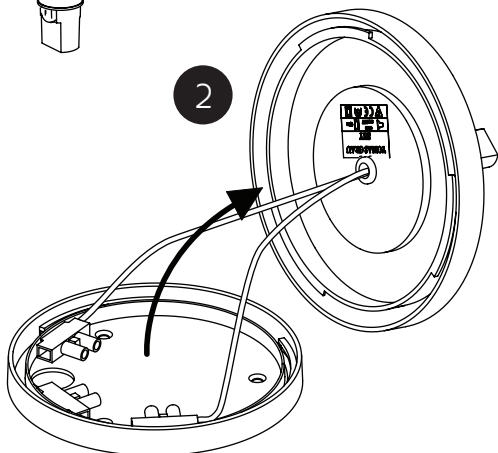

3

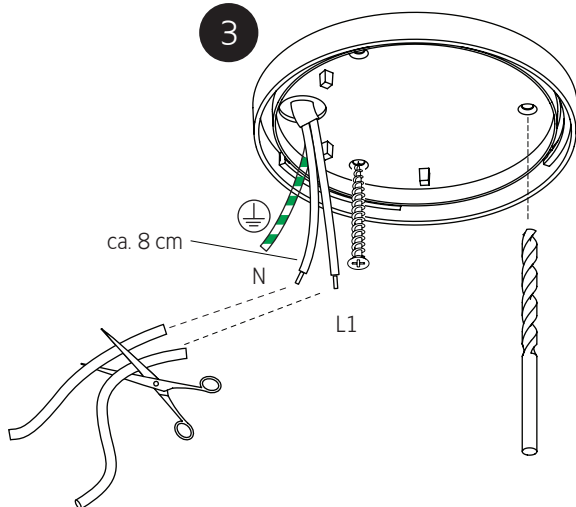

Montageanleitung • Assembly instruction • Notice de montage • Istruzioni montaggio

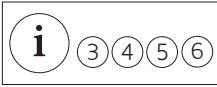

4

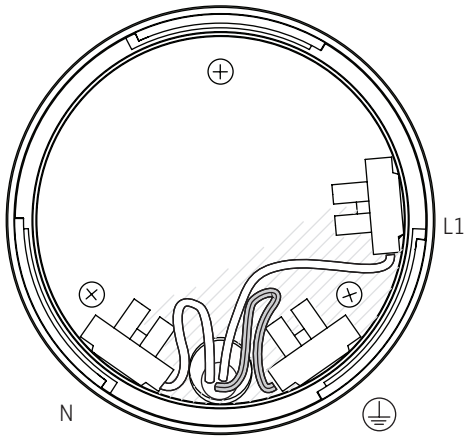

YES

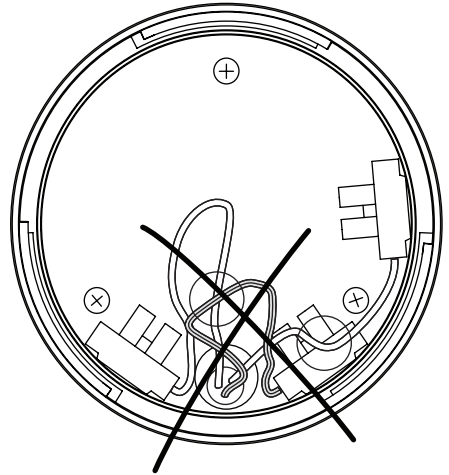

NO

5

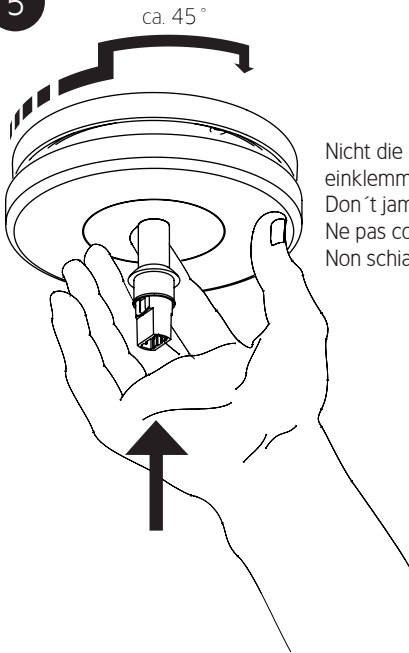



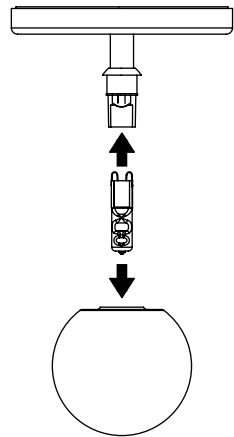

Nicht die Kabel
einklemmen!
Don't jam the cables!
Ne pas coincer les câbles!
Non schiacciare i cavi!

6



i DEUTSCH

- ① Die Auswahl der richtigen Befestigungsmittel obliegt dem Installateur.
- ② Schutzschläuche über die ganze Länge der Deckenanschlussabel ziehen.
- ③ Nicht die Kabel einklemmen!
- ④ Lassen Sie das Leuchtmittel vor dem Wechsel abkühlen.
- ⑤ Den Glaskolben nicht mit den Fingern anfassen.
- ⑥ Dimmer für Halogen-Hochvoltlampen verwenden.
- ⑦ Bitte die Leuchte ausschließlich mit einem trockenen Tuch reinigen. Wir empfehlen Microfasertücher für empfindliche Oberflächen. Das Reinigen muss in abgekühltem Zustand erfolgen.

SHY BALL	
	Montage auf normal entflammaren Flächen zulässig.
	Schutzklasse 2
	Niederdrucklampen verwenden!
	73/23/EWG 89/336/EWG
	G9 max. 60W - ES 48W



Diese Leuchte ist geeignet für Leuchtmittel der Energieklasse:
Diese Leuchte wird verkauft mit einem Leuchtmittel der Energieklasse:





E - A++
D

Garantie:

Sie haben ein hochwertiges Produkt erworben, welches mit Sorgfalt produziert und verpackt worden ist. Sollten Sie dennoch einmal Grund zur Beanstandung haben, wenden Sie sich bitte ausschließlich an Ihr Einrichtungs- bzw. Leuchtenhaus. Geben Sie bitte die auf der letzten Seite genannte Endkontrollnummer an. Ihre Reklamation wird bei uns im Hause umgehend bearbeitet. Bitte haben Sie Verständnis, dass eine Garantie unsererseits nur bei sachgemäßer Montage übernommen werden kann - wir empfehlen daher Fachbetriebe. Fragen Sie auch Ihr Einrichtungs- bzw. Leuchtenhaus diesbezüglich.

i ENGLISH

- ① It is the installer`s responsibility to choose the correct fixing method.
- ② Cover the whole lenght of the ceiling electrical cable with the attached protection tube.
- ③ Don`t jam the cables!
- ④ Please let the lighting element cool down before changing.
- ⑤ Don`t touch glass with fingers.
- ⑥ Use dimmers for high-voltage halogen lamps.
- ⑦ We recommend to clean the track with a dry cotton cloth only. We suggest micro-fibre raps for sensitive finishes. Cleaning must only be carried out when the lamp is cool.

SHY BALL	
	Mounting on normally flammable surfaces permissible.
	Protection class 2
	Use low pressure lamps!
	73/23/EWG 89/336/EWG GU 10 max. 50W
	G9 max. 60W - ES 48W



This luminaire is compatible with bulbs of the energy classes:
This luminaire is sold with a bulb of the energy class:





E - A++
D

Warranty:

You have acquired a high-quality product, which has been manufactured and packed with care. Should you nevertheless have grounds for complaint, please contact your local specialist furniture or lighting retailer, quoting the final inspection number as noted on the last page hereof. We will deal with your complaint immediately. This warranty applies only to products that have been fitted appropriately – we therefore recommend fitting by qualified personnel. Your local furniture or lighting specialist will be able to advise you accordingly.

i FRANÇAIS

- ① Le choix des moyens de fixations appropriés incombe à l'installateur.
- ② Veuillez recouvrir par le tuyau de protection toute la longueur du câble électrique sortant du plafond.
- ③ Ne pas coincer les câbles!
- ④ Laisser refroidir l'ampoule avant de la changer.
- ⑤ Ne pas toucher le verre avec les doigts.
- ⑥ Utiliser un variateur pour ampoule halogène haute tension.
- ⑦ Veuillez nettoyer le luminaire uniquement avec un chiffon sec. Nous recommandons des chiffons en microfibre. Le nettoyage doit s'effectuer uniquement lorsque la lampe est froide.

SHY BALL	
	Montage autorisé sur surface normalement inflammables.
	Catégorie de sécurité 2
	Utiliser des ampoules basse pression!
	73/23/EWG 89/336/EWG
	G9 max. 60W - ES 48W







Ce luminaire est prévu pour des sources lumineuses de classe énergétique: E - A++
Ce luminaire peut uniquement être équipé de tubes fluorescents compacts, classe énergétique: D

Garantie:

Vous avez fait l'acquisition d'un produit de haute qualité, fabriqué et emballé avec le plus grand soin. Si vous avez cependant un motif de réclamation, veuillez vous adresser immédiatement à votre magasin d'ameublement ou de luminaires, en indiquant le numéro de contrôle final mentionné à la dernière page. Notre société donnera suite sans tarder à votre réclamation. Vous comprenez aisément que nous ne pouvons assurer de garantie que dans le cas où le montage du matériel a été effectué correctement - par conséquent, nous vous recommandons de vous adresser à un spécialiste. Demandez conseil à votre magasin d'ameublement ou de luminaires.

i ITALIANO

- ① La scelta del giusto materiale per l'attacco spetta all'installatore.
- ② Inserire i tubi protettivi per tutta la lunghezza del cavo connettore.
- ③ Non schiacciare i cavi!
- ④ Fate raffreddare la lampadina prima di cambiarla.
- ⑤ Non toccare il vetro con le dita.
- ⑥ Utilizzare regolatori per lampade alogene ad alta tensione.
- ⑦ Per favore pulire la lampada esclusivamente con un panno asciutto. Si consiglia di utilizzare tessuti in microfibra. Le lampade devono essere fredde durante la pulizia.

SHY BALL	
	Montaggio autorizzato su superfici normalmente infiammabili.
	Categoria di sicurezza 2
	Utilizzare lampade a bassa pressione!
	73/23/EWG 89/336/EWG
	G9 max. 60W - ES 48W



Questa lampada è idonea a sorgenti luminose con classe energetica: **E - A++**
Questa lampada deve essere equipaggiata con una lampadina a risparmio di classe energetica: **D**

Garanzia:

Avete deciso di acquistare un prodotto d'alto valore, prodotto ed imballato con accuratezza. Qualora ci fossero motivazioni oggettive per un reclamo, indirizzarle immediatamente al vostro rivenditore o negozi specializzati. Indicare il numero di controllo finale riportato nell'ultima pagina. Il vostro reclamo verrà elaborato presso di noi. Considerate che da parte nostra possiamo assumere la garanzia del prodotto soltanto nel caso in cui il montaggio avvenga a regola d'arte: consigliamo dunque di rivolgersi ad aziende d'installazione specializzate; chiedere anche a tal riguardo al vostro rivenditore o a negozi specializzati.

Endkontrollnummer	2 Jahre Garantie
Final inspection number	2 years guarantee
Numéro de contrôle final	2 ans de garantie
Numero di controllo finale	2 anni di garanzia