

# PROJECT X

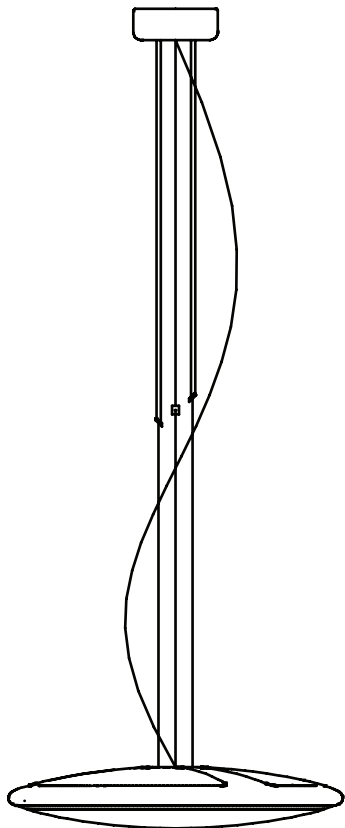

**LOBASGRAU**

Montageanleitung • Assembly instructions • Notice de montage • Istruzioni montaggio

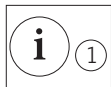

1

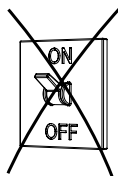

2

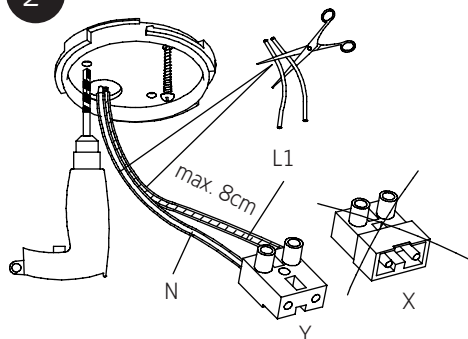

3

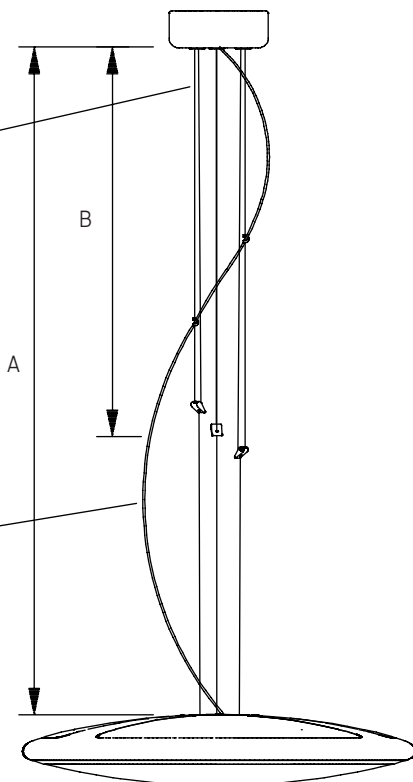
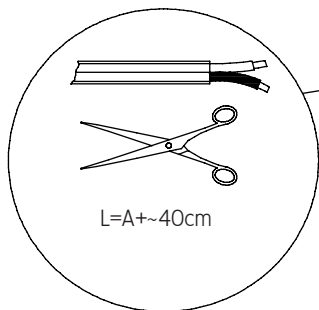
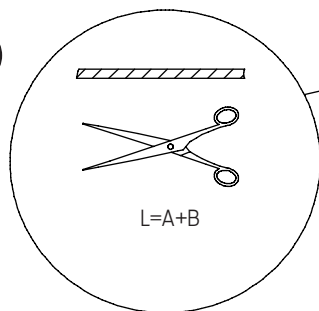

Montageanleitung • Assembly instructions • Notice de montage •  
Istruzioni montaggio

4

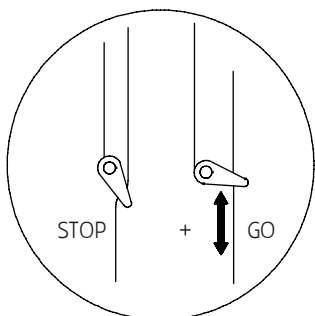
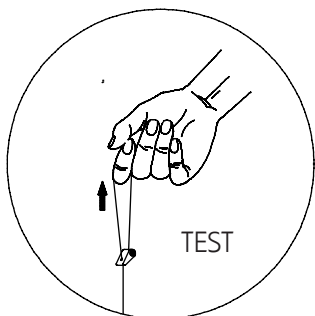
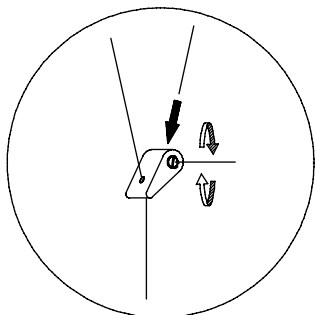

5

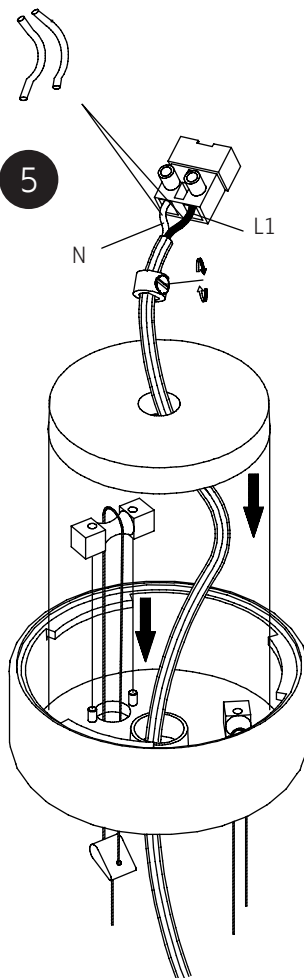

Montageanleitung • Assembly instructions • Notice de montage •  
Istruzioni montaggio

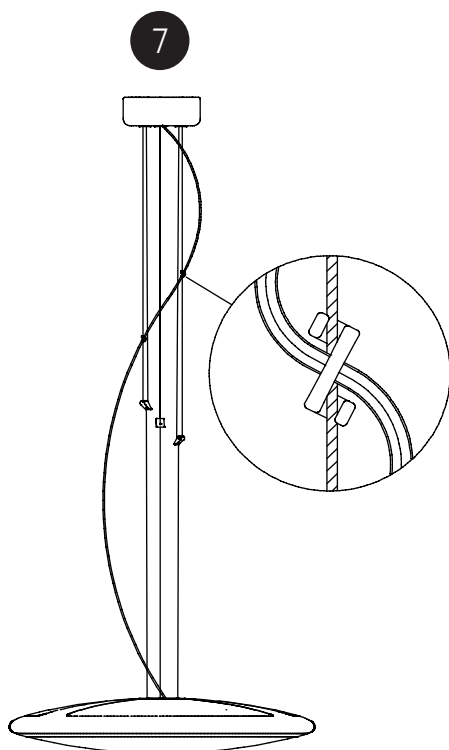
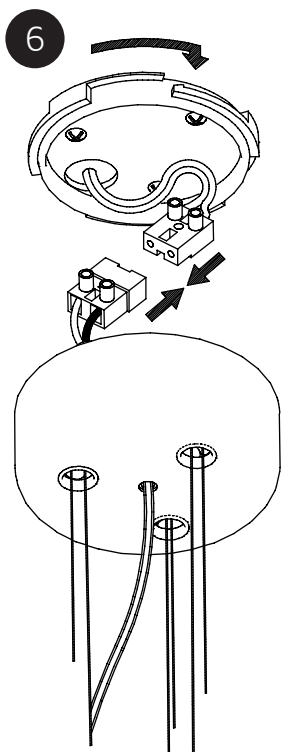



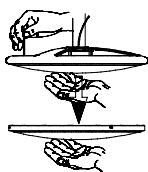
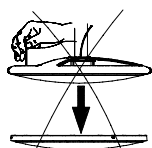
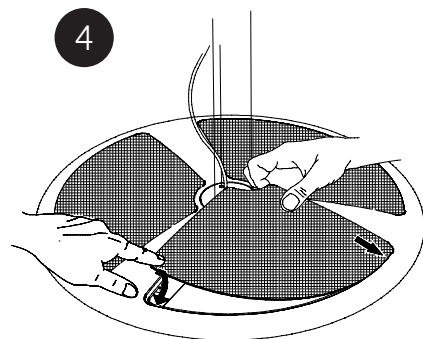
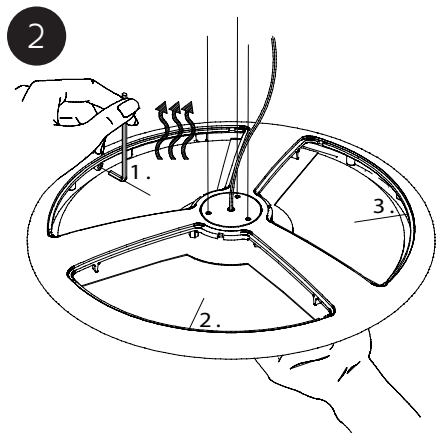
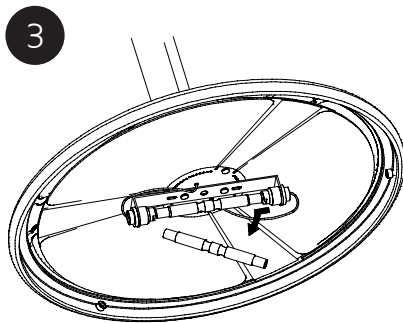
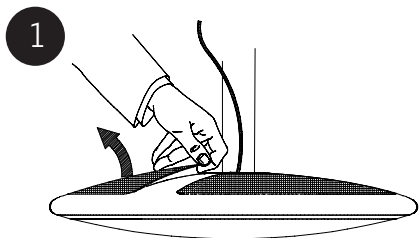
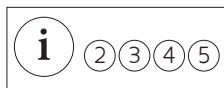



Wechseln des Leuchtmittels • Changing the means of illumination •  
Changement de l'ampoule • Sostituzione della lampadina

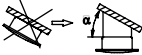

# **i** DEUTSCH

- ① Schutzschläuche über die ganze Länge der Deckenanschlusskabel überziehen. Teil Y montieren!
- ② Kein Werkzeug verwenden!
- ③ Einbau der Abdeckungen
- ④ Dimmer: Dimmer für Halogen-Hochvoltlampen verwenden.
- ⑤ Bitte die Leuchte ausschließlich mit einem trockenen Tuch reinigen. Wir empfehlen Microfasertücher für empfindliche Oberflächen. Das Reinigen muss in abgekühltem Zustand erfolgen. Bitte beachten Sie, dass bei häufiger Höhenverstellung der Leuchte die Seile verschleifen können. Dies sollte von Zeit zu Zeit überprüft werden. Wir wünschen Ihnen viel Freude mit Ihrer Leuchte.







PROJEKT X	
	Montage auf normal entflammaren Flächen zulässig.
	73/23/EWG   89/336/EWG
	Montageelemente für schräge Decken auf Anfrage.
	Schutzklasse 2
	Mindestabstand zu angestrahlten Flächen 0,3m!
 R7s / 114,2 mm max. 120W <b>ECÖ</b> /150W	

## Garantie:

Sie haben ein hochwertiges Produkt erworben, welches mit Sorgfalt produziert und verpackt worden ist. Sollten Sie dennoch einmal Grund zur Beanstandung haben, wenden Sie sich bitte ausschließlich an Ihr Einrichtungs- bzw. Leuchtenhaus. Geben Sie bitte die auf der letzten Seite genannte Endkontrollnummer an. Ihre Reklamation wird bei uns im Hause umgehend bearbeitet. Bitte haben Sie Verständnis, dass eine Garantie unsererseits nur bei sachgemäßer Montage übernommen werden kann - wir empfehlen daher Fachbetriebe. Fragen Sie auch Ihr Einrichtungs- bzw. Leuchtenhaus diesbezüglich.

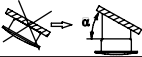
# **i** ENGLISH

- ① Cover the whole length of the ceiling electrical cable with the attached protection tube. Install the piece Y!
- ② Do not use any tools!
- ③ Installation of the covers.
- ④ Dimmers: Use dimmers for high-voltage halogen lamps.
- ⑤ Please clean the track/lamp with a dry cloth only. We recommend a micro-fibre cloth. Cleaning must only be carried out when the lamp is cool. Please take a note that the cable will show wear with frequent height adjustment of the lamp. This should be checked from time to time.  
We wish you long-lasting pleasure with your lamp.







PROJECT X	
	Suitability for direct mounting on normal flammable surfaces.
	73/23/EWG   89/336/EWG
	Mounting units for sloping roofs on request.
	Protection class 2
	Minimum distance from lighted objects 0,3m!
 R7s / 114,2 mm max. 120W  /150W	

## Warranty:

You have acquired a high-quality product, which has been manufactured and packed with care. Should you nevertheless have grounds for complaint, please contact your local specialist furniture or lighting retailer, quoting the final inspection number as noted on the last page hereof. We will deal with your complaint immediately. This warranty applies only to products that have been fitted appropriately – we therefore recommend fitting by qualified personnel. Your local furniture or lighting specialist will be able to advise you accordingly.

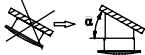
# i FRANÇAIS

- ① Veuillez recouvrir par le tuyau de protection toute la longueur du câble électrique sortant du plafond. Monter la pièce Y!
- ② Ne pas utiliser d'outil!
- ③ Montage des câches.
- ④ Utiliser un variateur pour ampoule halogène haute tension.
- ⑤ Veuillez nettoyer le luminaire uniquement avec un chiffon sec. Nous recommandons des chiffons en microfibre. Le nettoyage doit s'effectuer uniquement lorsque la lampe est froide. Veuillez noter, que lorsque de luminaire est souvent réglé en hauteur, cela peut user les câbles. Ceux-ci doivent être contrôlés de temps en temps. Nous vous souhaitons beaucoup de plaisir avec votre nouvelle lampe.

PROJEKT X	
	Montage autorisé sur surfaces normalement inflammables.
	73/23/EWG   89/336/EWG
	Éléments de montage pour les plafonds en pente sur demande.
	Protection de classe 2
	Distance minimale de la surfaces éclairée 0,3m!
 R7s / 114,2 mm max. 120W  /150W	







## Garantie:

Vous venez de faire l'acquisition d'un produit de haute qualité, fabriqué et emballé avec le plus grand soin. Si vous avez cependant un motif de réclamation, veuillez vous adresser immédiatement à votre magasin d'ameublement ou de luminaires, en indiquant le numéro de contrôle final mentionné à la dernière page. Notre société donnera suite sans tarder à votre réclamation. Vous comprenez aisément que nous ne pouvons assurer de garantie que dans le cas où le montage du matériel a été effectué correctement - par conséquent, nous vous recommandons de vous adresser à un spécialiste. Demandez conseil à votre magasin d'ameublement ou de luminaires.

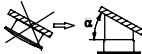

# **i** ITALIANO

- ① Inserire i tubi protettivi per tutta la lunghezza del cavo connettore. Montare il pezzo Y!
- ② Non utilizzare nessuno strumento!
- ③ Montaggio del le coperture.
- ④ Utilizzare regolatori per lampade alogene ad alta tensione.
- ⑤ Perfavore pulire la lampada esclusivamente con un panno asciutto. Si consiglia di utilizzare tessuti in microfibra. Le lampade devono essere fredde durante la pulizia. Si fa presente che ripetute regolazioni dell' altezza del lampadario usurano le funicelle. Occorre fare di tanto in tanto un opportuno controllo. Vi auguriamo di trascorrere molte ore liete illuminati dalla luce dalla Vostra lampada.

PROJECT X	
	Montaggio autorizzato su superfici normalmente infiammabili.
	73/23/EWG   89/336/EWG
	Elementi per montaggio su soffitti inclinati su richiesta.
	Protezione Classe 2
	0,3m    Distanza minima dagli oggetti da illuminare 0,3m!
 R7s / 114,2 mm max. 120W <b>ECÖ</b> /150W	

## Garanzia:

Avete deciso di acquistare un prodotto d' alto valore, prodotto ed imballato con accuratezza. Qualora ci fossero motivazioni oggettive per un reclamo, indirizzarle immediatamente al Vostro rivenditore o negozi specializzati. Indicare il numero di controllo finale riportato nell' ultima pagina. Il Vostro reclamo verrà elaborato presso di noi. Considerate che da parte nostra possiamo assumere la garanzia del prodotto soltanto nel caso in cui il montaggio avvenga a regola d' arte: consigliamo dunque di rivolgersi ad aziende d' installazione specializzate; chiedere anche a tal riguardo al Vostro rivenditore o a negozi specializzati.





Endkontrollnummer	2 Jahre Garantie
Final inspection number	2 years guarantee
Numéro de contrôle final	2 ans de garantie
Numero di controllo finale	2 anni di garanzia